

Caractéristiques de construction

● Aluminium anodisé
 ● Acier zingué
 ● Aluminium moulé

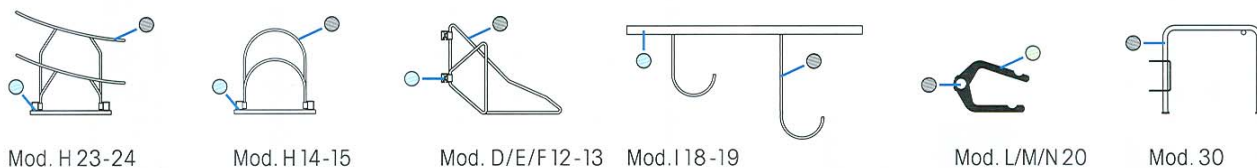

Mod. H 23-24



Mod. 23

Mod. 24

Mod. H 23-24

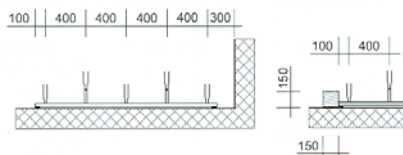

	cm	
5	180	2
7	260	3
9	340	3
11	420	4
13	500	4

Mod. H 14-15



Mod. 14

Mod. 15

Mod. H 14-15

Mod. 12-13



Mod. 12



Mod. 13

Mod. D 12-13

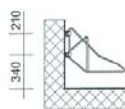

Mod. E 12-13

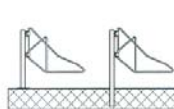

Mod. F 12-13

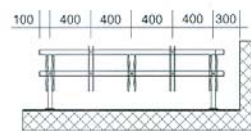
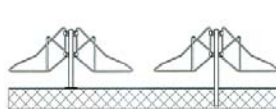

	cm	
5	180	3x2
7	260	3x2
9	340	4x2
11	420	4x2
13	500	5x2

	cm	
5	180	3
7	260	3
9	340	4
11	420	4
13	500	5

	cm	
10	180	3
14	260	3
18	340	4
22	420	4
26	500	5

Mod. I 18-19



Mod. 18



Mod. 19

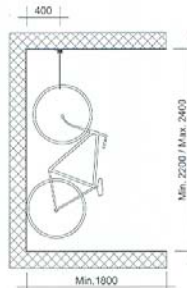
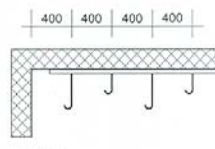

Mod. I 18-19 A

	cm	
5	180	3
7	260	4
9	340	5
11	420	6
13	500	7

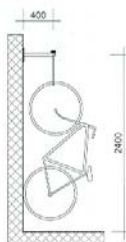

Mod. I 18-19 B

	cm	
5	180	3
7	260	3
9	340	4
11	420	4
13	500	5

Support à vélos CICLOPARK

Mod. 20

Mod. L20

Mod. M20

Mod. N20

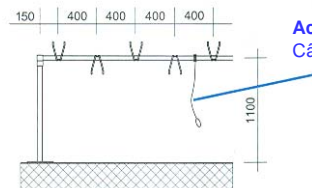
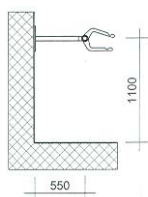

Accessoires
Câble antivol

Mod. L20

Mod. M20

Mod. N20

	cm	
5	190	2
7	270	2
9	350	2
11	430	3
13	510	3

	cm	
5	190	2
7	270	2
9	350	2
11	430	3
13	510	3

	cm	
10	210	2
14	290	2
18	370	2
22	450	3
26	530	3

Mod. 30









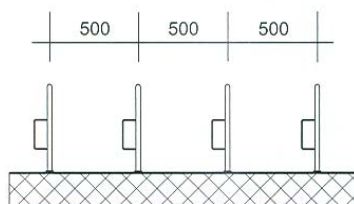

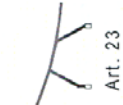
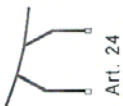
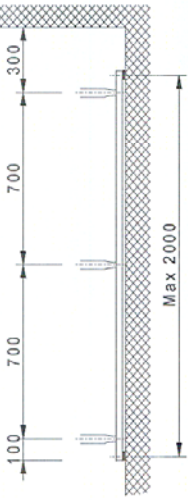

Mod. 30.01

Mod. 30.01K

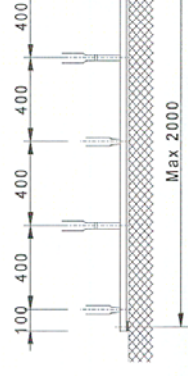

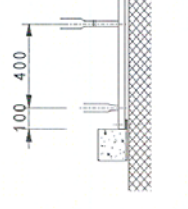





Mod. 30.02

Mod. 30.02K

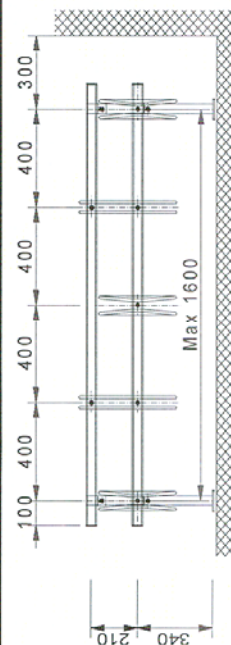
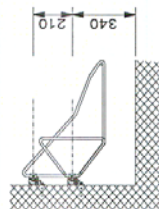
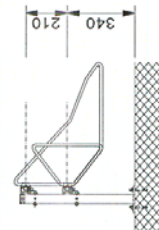
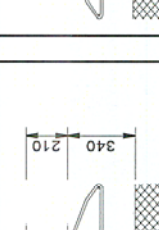
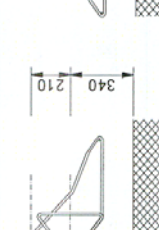

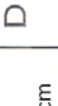



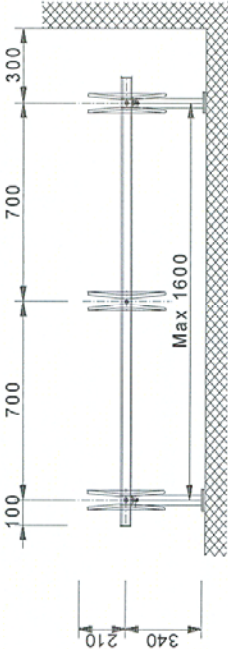
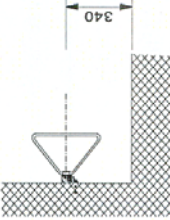
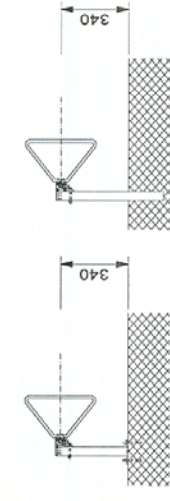

Supports à vélos		LISTE DE PRIX 2012			
		 H14  H1415  H23  H2324			
Mod. H14 - H23  Art. 23  Art. 24  Max 2000  100		Mod. H1415 - H2324  Max 2000  100 400 400 400 400 300  100 400			
	cm		cm		
4	230	3	H14	H23	440.00
5	300	3	390.00	H23	440.00
6	370	3	490.00	H23	550.00
7	440	4	500.00	H23	565.00
8	510	4	690.00	H23	775.00
		4	785.00	H23	875.00
		2	H14	H14	400.00
		3	H14	H14	575.00
		3	H14	H14	725.00
		4	H14	H14	900.00
		4	H14	H14	1'050.00
		5	H14	H14	1'165.00
		7	H14	H14	450.00
		9	H14	H14	640.00
		11	H14	H14	810.00
		13	H14	H14	1'000.00
					1'165.00
<ul style="list-style-type: none"> • TVA non comprise • Finition en aluminium éloxé naturel 		<ul style="list-style-type: none"> • Transport non compris • RAL au choix 			
		Bloc de granit Fr. 255.-/pce 			

Liste de prix supports à vélos

Supports à vélos		LISTE DE PRIX 2012	
 Art. 12	 Art. 13		
<p>Mod. D1213</p> 		<p>Mod. E1213</p> 	
<p>Mod. F1213</p> 			
	cm		
5 3xE12 + 2xE13	180	3x2	3
7 4xE12 + 3xE13	260	3x2	3
9 5xE12 + 4xE13	340	4x2	4
11 6xE12 + 5xE13	420	4x2	4
13 7xE12 + 6xE13	500	5x2	5
	cm		
10 6xF12 + 4xF13	180	3	3
14 8xF12 + 6xF13	260	3	3
18 10xF12 + 8xF13	340	4	4
22 12xF12 + 10xF13	420	4	4
26 14xF12 + 12xF13	500	5	5
<ul style="list-style-type: none"> • TVA non comprise • Finition en acier zingué • Transport non compris 		<ul style="list-style-type: none"> • Finition en aluminium éloxé naturel • RAL au choix 	

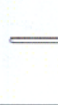
Liste de prix supports à vélos

Supports à vélos		LISTE DE PRIX 2012	
			
Art. 12			
			
Mod. A12		Mod. B12	
			
	cm	A	B
4	230	3	3
5	300	3	3
6	370	4	4
7	440	4	4
8	510	5	5
<ul style="list-style-type: none"> • TVA non comprise • Finition en acier zingué 		<ul style="list-style-type: none"> • Transport non compris 	
Mod. C12		Mod. C12	
			
	cm		
8	230	3	3
10	300	3	3
12	370	4	4
14	440	4	4
16	510	5	5
<ul style="list-style-type: none"> • Finition en aluminium éloxé naturel • RAL au choix 			

LISTE DE PRIX 2012



Supports à vélos

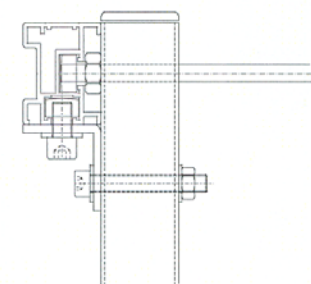

Art. 18





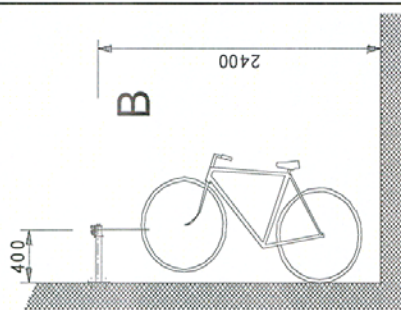
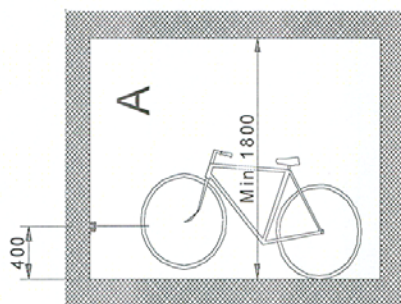
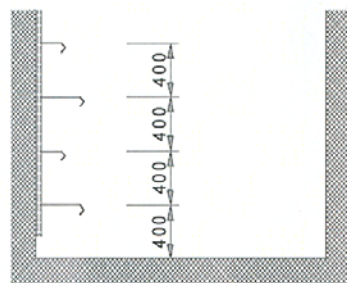

Art. 19





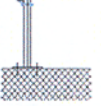

Mod. I / A

Mod. I / B

	cm		
5	180	3	3
7	260	3	3
9	340	4	4
11	420	4	4
13	500	5	5

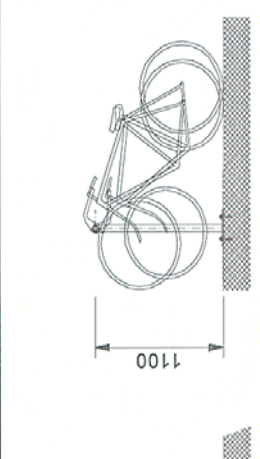
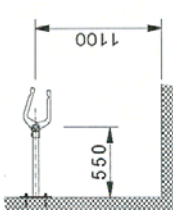
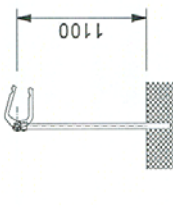
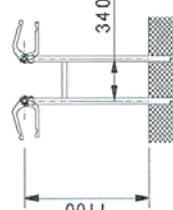
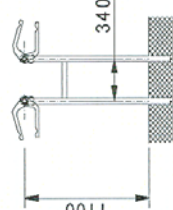
	cm		
5	180	3	350.00
7	260	3	415.00
9	340	4	540.00
11	420	4	610.00
13	500	5	740.00

• TVA non comprise • Finition en acier zingué • Transport non compris • Finition en aluminium éloxé naturel • RAL au choix

Supports à vélos		LISTE DE PRIX 2012	
 <p>Art. 20</p>			
Mod. L20		Mod. M20	
			
	M		
cm	cm	cm	cm
5	2	2	2
7	2	2	2
9	2	2	2
11	3	3	3
13	3	3	3
500.00	615.00	1'040.00	1'010.00
535.00	785.00	1'215.00	1'135.00
665.00	950.00	1'385.00	1'465.00
835.00	1'085.00	1'560.00	1'790.00
1'040.00	1'250.00	1'735.00	2'090.00
1'200.00	1'385.00	2'010.00	2'415.00
<ul style="list-style-type: none"> • TVA non comprise 	<ul style="list-style-type: none"> • Finition en acier zingué 	<ul style="list-style-type: none"> • Transport non compris 	<ul style="list-style-type: none"> • Finition en aluminium éloxé naturel
	<ul style="list-style-type: none"> • RAL au choix 		

Support à vélos

Support à vélos EASYLINE

En acier galvanisé, le support individuel peut servir de module complémentaire, y compris 4 brides de fixation au sol.

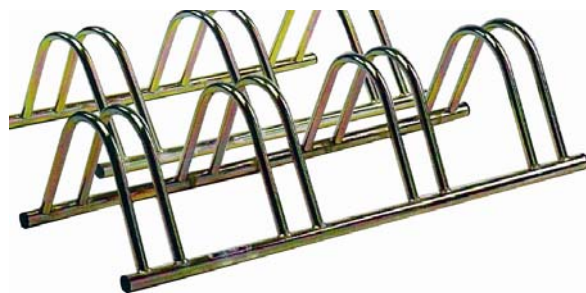

Longueur	Distance	Support	N°article	Prix
390	300	1	9FSEA1	47.-
735	300	3	9FSEA3	78.-
1050	300	4	9FSEA4	104.-



Support à vélos ECOLINE

En acier galvanisé, pour Mountainbikes, système modulaire, rallongeable à volonté.

Disponible du stock

Support	Élément	Long. totale	N°article	Prix
2	1 x 2er	700	9FSEC2	91.-
3	1 x 3er	1050	9FSEC3	126.-
4	2 x 2er	1400	9FSEC4	182.-
5	1 x 3er + 1 x 2er	1750	9FSEC5	217.-
6	2 x 3er	2100	9FSEC6	252.-
7	2 x 2er + 1 x 3er	2450	9FSEC7	308.-
8	2 x 3er + 1 x 2er	2800	9FSEC8	343.-
9	3 x 3er	3150	9FSEC9	378.-
10	2 x 3er + 2 x 2er	3500	9FSEC10	434.-
11	3 x 3er + 1 x 2er	3850	9FSEC11	469.-
12	4 x 3er	4200	9FSEC12	504.-
13	3 x 3er + 2 x 2er	4550	9FSEC13	560.-
14	4 x 3er + 1 x 2er	4900	9FSEC14	595.-
15	5 x 3er	5250	9FSEC15	630.-
16	4 x 3er + 2 x 2er	5600	9FSEC16	686.-

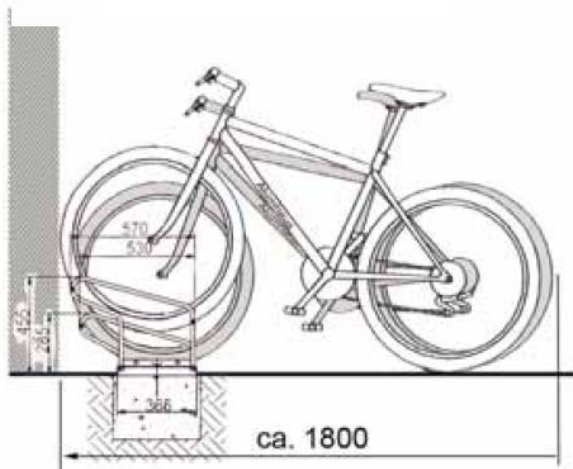

Support à vélos

91.5216.10

Support à vélos

En acier zingué, crochet revêtu de caoutchouc, pour City et Mountainbike.

Distance de montage à respecter :

Horizontalement entre crochets **350 mm**
Sol-crochet inférieur **1780 mm**
Sol-crochet supérieur **1950 mm**

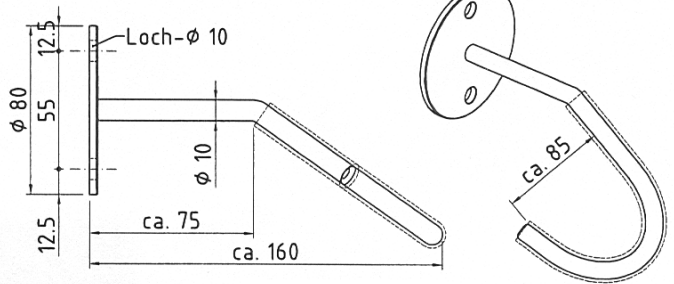

91.5216.10

Pincés à vélos

Les pincés, cannelées à l'intérieur, donnent un maintien aisé en poussant simplement la roue avant.

Parquage sur 1 niveau

91.5218.00

En acier zingué, pour montage mural, réglable 180°.

91.5220.01

En acier zingué, montage au sol par poteau à sceller.

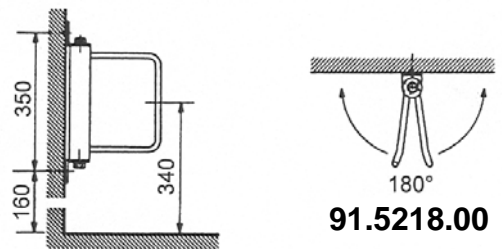

91.5218.00

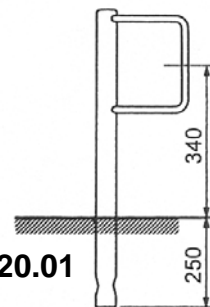

91.5220.01

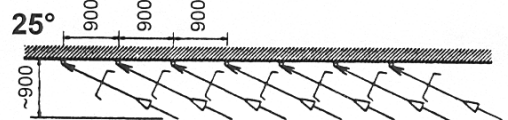
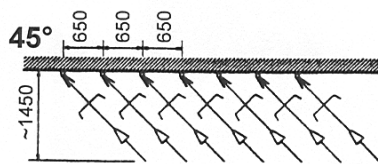
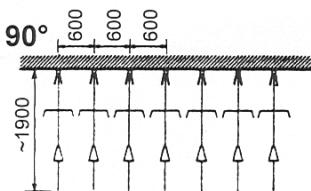

Parquage sur 1 niveau

91.5224.00

Pincés à vélos réglage 180°

En acier zingué au feu, pour montage mural, combiné avec no 91.5218.00

Utilisation simple :

Lorsque vous crochez la jante sur le support, la roue se bloque automatiquement sur la pince.

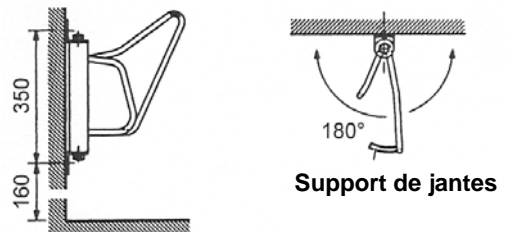

Support de jantes

Parquage au sol

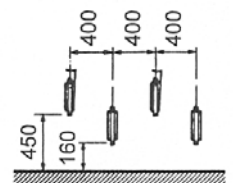
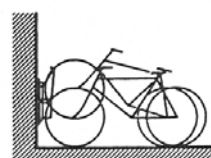

91.5224.00

Support à vélos

Support à vélos SKYLINE

Pour montage mural ou au plafond, crochets
Avec revêtement synthétique.

Longueur de crochet : 250/420 mm

Distance de crochet : 350 mm



Montage plafond	Crochet	N° article	Prix
Equerre de montage sans console murale	4	9FSSK4D	209.-
	8	9FSSK8D	419.-

Montage mural	Crochet	N° article	Prix
Avec console murale	4	9FSSK4W	273.-
	8	9FSSK8W	482.-

Support à vélos Modèle FH

Crochets individuels en fonte d'aluminium plastifié rouge ou brut, avec protection de la jante en caoutchouc, pour tous les modèles de vélo.

Exécution	Support	N° article	Prix
Plastifié rouge	1	9FH10	22.-
Brut avec protection	1	9FH20	17.-

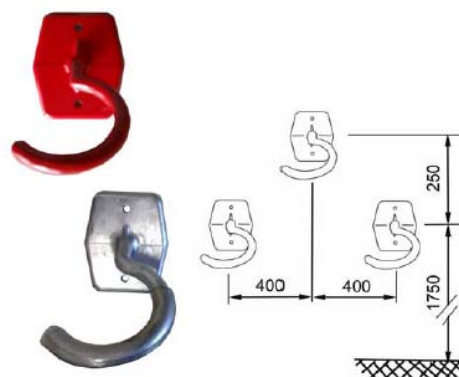

Support à vélos EASY-TOP avec guidage de roue

Crochets individuels en fonte d'aluminium, pour Mountain-Bikes, guidage de roue avec protection pour le pneu, utilisable 90° + 45°.

Exécution	Support	N° article	Prix
Brut avec protection	1	9FH50	71.-

